

### Table of Contents

Title	Page
Overview - - - - -	3
Unpacking Inspection - - - - -	4
Safety Information - - - - -	5
Rules For Safe Operation - - - - -	6
International Electrical Symbols - - - - -	8
The Meter Structure - - - - -	9
Rotary Switch - - - - -	10
Functional Buttons - - - - -	11
The Effectiveness of Functional Buttons - - - - -	12
Display Symbols - - - - -	13
Measurement Operation - - - - -	15
A. DC Voltage Measurement - - - - -	15
B. AC Voltage Measurement - - - - -	16
C. Measuring Resistance - - - - -	17
D. Testing Diodes - - - - -	19
E. Testing for Continuity - - - - -	20
F. Temperature Measurement - - - - -	22
G. AC Current Measurement - - - - -	23
Sleep Mode - - - - -	25
Specifications - - - - -	26
A. General Specifications - - - - -	26
B. Environmental Restriction - - - - -	26
Accuracy Specifications - - - - -	27
A. AC Voltage - - - - -	27
B. DC Voltage - - - - -	27
C. Resistance - - - - -	28
D. Continuity Test - - - - -	28
E. Diode Test - - - - -	28
F. Temperature - - - - -	29
G. AC Current - - - - -	29
Maintenance - - - - -	30
A. General Service - - - - -	30
B. Replacing the Battery - - - - -	30

**UNI-T**®

**Model UT201/202: OPERATING MANUAL**

### Overview

This Operating Manual covers information on safety and cautions. Please read the relevant information carefully and observe all the Warnings and Notes strictly.

#### **Warning**

**To avoid electric shock or personal injury, read the “Safety Information” and “Rules for Safe Operation” carefully before using the Meter.**

Digital Multimeter Model UT201/202 (hereafter referred to as “the Meter”) are 3 1/2 digits with steady operations, fashionable structure and highly reliable measuring instrument. The Meter uses large scale of integrated circuit with double integrated A/D converter as its core and has full range overload protection.

The Meter can measure AC/DC Voltage, AC Current, Resistance, Temperature( °F/ °C), Diodes, Continuity and so on.



Model UT201/202: OPERATING MANUAL

## Unpacking Inspection

Open the package case and take out the Meter. Check the following items carefully to see any missing or damaged part:

Item	Description	Qty
1	English Operating Manual	1 piece
2	Test Lead	1 pair
3	Point Contact Temperature Probe (UT202 only)	1 piece
4	1.5V Battery (AAA)	2 pieces

In the event you find any missing or damage, please contact your dealer immediately.

### Safety Information

This Meter complies with the standards IEC61010: in pollution degree 2, overvoltage category (CAT. II 600V, CAT. III 300V) and double insulation.

CAT. II: Local level, appliance, PORTABLE EQUIPMENT etc., with smaller transient overvoltages than CAT. III.  
CAT. III: Distribution level, fixed installation, with smaller transient overvoltages than CAT. IV

Use the Meter only as specified in this operating manual, otherwise the protection provided by the Meter may be impaired.

In this manual, a **Warning** identifies conditions and actions that pose hazards to the user, or may damage the Meter or the equipment under test.

A **Note** identifies the information that user should pay attention to.

International electrical symbols used on the Meter and in this Operating Manual are explained on page 8.

## Rules For Safe Operation (1)

### Warning













To avoid possible electric shock or personal injury, and to avoid possible damage to the Meter or to the equipment under test, adhere to the following rules:

- 1 Before using the Meter inspect the case. Do not use the Meter if it is damaged or the case (or part of the case) is removed. Look for cracks or missing plastic. Pay attention to the insulation around the connectors.
- 1 Inspect the test leads for damaged insulation or exposed metal. Check the test leads for continuity. Replace damaged test leads with identical model number or electrical specifications before using the Meter.
- 1 Do not apply more than the rated voltage, as marked on the Meter, between the terminals or between any terminal and grounding. If the value to be measured is unknown, use the maximum measurement position and reduce the range step by step until a satisfactory reading is obtained.
- 1 When measurement has been completed, disconnect the connection between the test leads and the circuit under test, remove the testing leads away from the input terminals of the Meter and turn the Meter power off.
- 1 The rotary switch should be placed in the right position and no any changeover of range shall be made during measurement is conducted to prevent damage of the Meter.
- 1 Do not carry out the measurement when the Meter's back case and battery compartment are not closed to avoid electric shock.
- 1 Do not input higher than 600V between the Meter's terminals and the grounding to avoid electric shock and damages to the Meter.

## Rules For Safe Operation (2)

- 1 When the Meter working at an effective voltage over 60V in DC or 30V rms in AC, special care should be taken for there is danger of electric shock.
- 1 Use the proper terminals, function, and range for your measurements.
- 1 Do not use or store the Meter in an environment of high temperature, humidity, explosive, inflammable and strong magnetic field. The performance of the Meter may deteriorate after dampened.
- 1 When using the test leads, keep your fingers behind the finger guards.
- 1 Disconnect circuit power and discharge all high-voltage capacitors before testing resistance, continuity and diode.
- 1 Replace the battery as soon as the battery indicator  appears. With a low battery, the Meter might produce false readings that can lead to electric shock and personal injury.
- 1 When servicing the Meter, use only the same model number or identical electrical specifications replacement parts.
- 1 The internal circuit of the Meter shall not be altered at will to avoid damage of the Meter and any accident.
- 1 Soft cloth and mild detergent should be used to clean the surface of the Meter when servicing. No abrasive and solvent should be used to prevent the surface of the Meter from corrosion, damage and accident.
- 1 The Meter is suitable for indoor use.
- 1 Turn the Meter off when it is not in use and take out the battery when not using for a long time.
- 1 Constantly check the battery as it may leak when it has been using for some time, replace the battery as soon as leaking appears. A leaking battery will damage the Meter.

### International Electrical Symbols

	AC (Alternating Current).
	DC (Direct Current).
	AC or DC.
	Grounding.
	Double Insulated.
	Deficiency of Built-In Battery
	Continuity Test.
	Diode.
	Capacitance Test
	Fuse.
	Warning. Refer to the Operating Manual.
	Conforms to Standards of European Union.



### The Meter Structure (see figure 1)

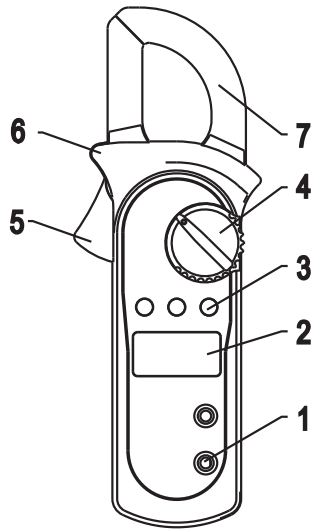

( figure 1)

1. Input Terminals
2. LCD Display
3. Functional Buttons
4. Rotary Switch
5. Trigger: press the lever to open the transformer jaws. When the pressure on the lever is released, the jaws will close.
6. Hand Guards: to protect user's hand from touching the dangerous area.
7. Transformer Jaws: designed to pick up the AC current flowing through the conductor. It could transfer current to voltage.





## Rotary Switch

Below table indicated for information about the rotary switch positions.

Rotary Switch Position	Function
OFF	Power is turned off.
$V \sim$	AC/DC voltage measurement.
$\rightarrow   \leftarrow$	$\rightarrow   \leftarrow$ : Diode test.
$\bullet \text{---}   \text{---} \bullet$	$\bullet \text{---}   \text{---} \bullet$ : Continuity test.
$\Omega$	$\Omega$ : Resistance measurement.
$^{\circ}C^{\circ}F$	Temperature measurement (UT202 only)
$A \sim$	AC current measurement range from 0.001A to 400.0A

### Functional Buttons(1)

Below table indicated for information about the functional button operations.

AC	voltage measurement.
<b>HOLD</b> 	<ul style="list-style-type: none"> <li>1 Press <b>HOLD</b>  to enter and exit the Hold mode in any mode, the Meter beeps.</li> <li>1 Press and hold <b>HOLD</b>  button while turning on the Meter to display full icons.</li> </ul>
<b>MAX</b>	Press <b>MAX</b> to start recording and updating of maximum values.
<b>SELECT</b>	Press <b>SELECT</b> button to switch between $\Omega$  and °C°F .

### The Effectiveness of Functional Buttons

Not every functional buttons can be used on every rotary switch positions. Below two tables describe which functional buttons can be used on which rotary switch positions

#### Model: UT201

Rotary Switch Positions	Functional Buttons		
	SELECT	MAX	HOLD 
$V \text{ } \ddot{\sim}$	N/A	•	•
$V \sim$	N/A	•	•
$\Omega$	N/A	N/A	•
$\rightarrow$	•	N/A	•
$A \sim 2/20A$	N/A	•	•
$A \sim 200/400A$	N/A	•	•

#### Model: UT202

Rotary Switch Positions	Functional Buttons		
	SELECT	MAX	HOLD 
$V \text{ } \ddot{\sim}$	N/A	•	•
$V \sim$	N/A	•	•
$\Omega \rightarrow$	•	N/A	•
$^{\circ}F(^{\circ}C(K\text{-Type}))$	•	N/A	•
$A \sim 2/20A$	N/A	•	•
$A \sim 200/400A$	N/A	•	•

### Display Symbols(1) (see figure 2)

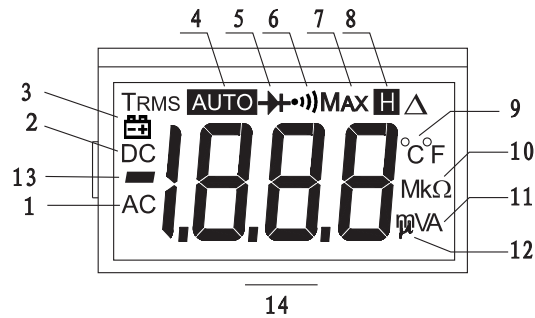

No.	Symbol	Meaning
1	AC	Indicator for AC voltage or current
2	DC	Indicator for DC voltage
3		The battery is low. <b>⚠ Warning: To avoid false readings, which could lead to possible electric shock or personal injury, replace the battery as soon as the battery indicator appears.</b>
4	<b>AUTO</b>	The Meter is in the auto range mode in which the Meter automatically selects the range with the best resolution.
5		Test of diode.
6		The continuity buzzer is on.
7	<b>MAX</b>	Maximum reading displayed
8	<b>H</b>	Date hold is active.
9	°C°F	The unit of temperature: °C: Centigrade temperature °F: Fahrenheit temperature
10	Ω, kΩ, MΩ	Ω: Ohm. The unit of resistance. kΩ: kilohm. $1 \times 10^3$ or 1000 ohms. MΩ: Megaohm. $1 \times 10^6$ or 1,000,000 ohms.

## Display Symbols(2) (see figure 2)

No.	Symbol	Meaning
11	<b>A</b>	Amperes (amps). The unit of current.
12	<b>mV, V</b>	Volts. The unit of voltage.mV: Millivolt. $1 \times 10^{-3}$ or 0.001 volts
13	<b>—</b>	Indicates negative reading
14	<b>OL</b>	The input value is too large for the selected range

## Measurement Operation(1)

### A. DC Voltage Measurement (see figure 3)

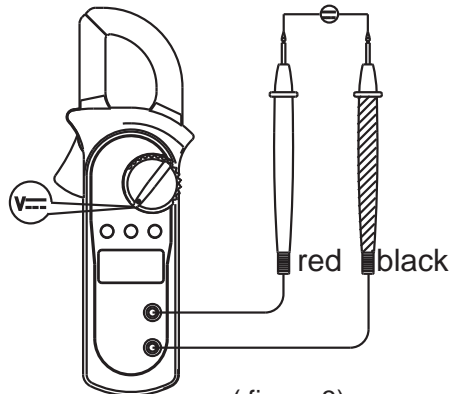

( figure 3)

#### Warning

To avoid harms to you or damages to the Meter from electric shock, do not attempt to measure voltages higher than 600V AC/DC, although readings may be obtained.

The DC Voltage ranges are:  
200.0mV, 2.000V, 20.00V, 200.0V and 600V.

To measure DC voltage, connect the Meter as follows:

1. Insert the red test lead into the  $\bullet \rightarrow \text{V}\Omega$  terminal and the black test lead into the **COM** terminal.
2. Set the rotary switch to  $\text{V}\text{—}$ .
3. Connect the test leads across with the object being measured.

The measured value shows on the display.

#### Note

- 1 In each range, the Meter has an input impedance of 10M $\Omega$ . This loading effect can cause measurement errors in high impedance circuits. If the circuit impedance is less than or equal to 10k $\Omega$ , the error is negligible (0.1 or less).

## Measurement Operation(2)

- 1 When DC voltage measurement has been completed, disconnect the connection between the testing leads and the circuit under test and remove testing leads from the input terminals.

### B. AC Voltage Measurement (see figure 4)

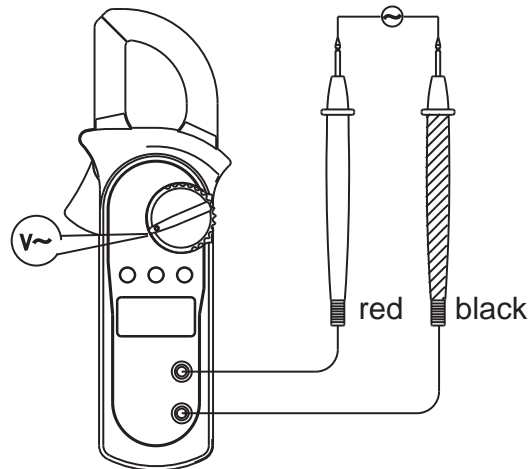

( figure 4)

### Warning

To avoid harms to you or damages to the Meter from electric shock, do not attempt to measure voltages higher than 600V AC/DC, although readings may be obtained.

The AC Voltage ranges are:  
2.000V, 20.00V, 200.0V and 600V.

To measure AC voltage, connect the Meter as follows:

1. Insert the red test lead into the  $V\Omega$  terminal and the black test lead into the **COM** terminal.
2. Set the rotary switch to  $V\sim$
3. Connect the test leads across with the object being measured.

The measured value shows on the display.



### Measurement Operation(3)

#### Note

- 1 In each range, the Meter has an input impedance of  $10\text{M}\Omega$ . This loading effect can cause measurement errors in high impedance circuits. If the circuit impedance is less than or equal to  $10\text{k}\Omega$ , the error is negligible (0.1 or less).
- 1 When AC voltage measurement has been completed, disconnect the connection between the testing leads and the circuit under test and remove testing leads from the input terminals.

### C.Measuring Resistance (see figure 5)

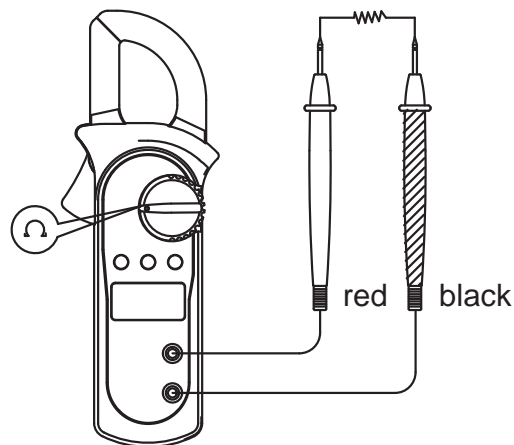

( figure 5)

#### Warning

To avoid harms to you, do not attempt to input voltages higher than 60V DC or 30V rms AC.

To avoid damages to the Meter or to the devices under test, disconnect circuit power and discharge all the high-voltage capacitors before measuring resistance.

## Measurement Operation(4)

The resistance ranges are:

200.0 $\Omega$ , 2.000k $\Omega$ , 20.00k $\Omega$ , 200k $\Omega$ , 2.000M $\Omega$  and 20.00M $\Omega$ .

To measure resistance, connect the Meter as follows:

1. Insert the red test lead into the  $V\Omega$  terminal and the black test lead into the **COM** terminal.
2. Set the rotary switch to  $\Omega$  ; resistance measurement ( $\Omega$ ) is default or press **SELECT** button to select  $\Omega$  measurement mode.
3. Connect the test leads across with the object being measured.

The measured value shows on the display.

### Note:

The test leads can add 0.1 $\Omega$  to 0.3 $\Omega$  of error to resistance measurement.

- 1 For high-resistance measurement (>1M $\Omega$ ), it is normal taking several seconds to obtain a stable reading.
- 1 If  $\Omega$  reading with shorted test leads is not  $\leq 0.5\Omega$ , check for loose test leads, wrong function selected, or enabled data hold function.
- 1 The LCD displays **OL** indicating open-circuit or the tested resistor value is higher than the maximum range of the Meter.
- 1 Resistance measurement is default to auto range mode.
- 1 To remove the objects being tested from the circuit when measuring can obtain a more accurate result.
- 1 When resistance measurement has been completed, disconnect the connection between the testing leads and the circuit under test and remove testing leads from the input terminals.

## Measurement Operation(5)

### D. Testing Diodes (see figure 6)

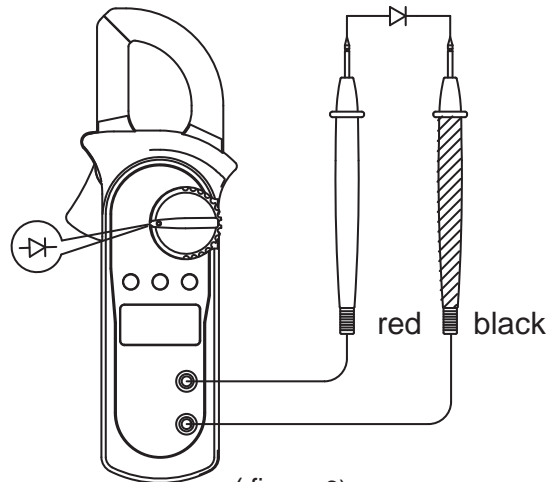

( figure 6)

#### Warning

To avoid damages to the Meter or to the devices under test, disconnect circuit power and discharge all the high-voltage capacitors before testing diodes.

Use the diode test to check diodes, transistors, and other semiconductor devices. The diode test sends a current through the semiconductor junction, then measure the voltage drop across the junction. A good silicon junction drops between 0.5V and 0.8V.

To test the diode out of a circuit, connect the Meter as follows:

1. Insert the red test lead into the  $\Omega \cdot \rightarrow \rightarrow V\Omega$  terminal and the black test lead into the **COM** terminal.
2. Set the rotary switch to  $\Omega \cdot \rightarrow \rightarrow \rightarrow$  and press **SELECT** button to select  $\rightarrow \rightarrow$  measurement mode.
3. For forward voltage drop readings on any semiconductor component, place the red test lead on the component's anode and place the black test lead on the component's cathode.

## Measurement Operation(6)

### Note

- 1 In a circuit, a good diode should still produce a forward voltage drop reading of 0.5V to 0.8; however, the reverse voltage drop reading can vary depending on the resistance of other pathways between the probe tips.
- 1 Connect the test leads to the proper terminals as said above to avoid error display.
- 1 The LCD will display **OL** indicating either open circuit or wrong polarity connection.
- 1 The unit of diode is volt (V), displaying the forward voltage drop readings.
- 1 To remove the objects being tested from the circuit when measuring can obtain a more accurate result.
- 1 When diode testing has been completed, disconnect the connection between the testing leads and the circuit under test and remove testing leads from the input terminals.

## E. Testing for Continuity (see figure 7)

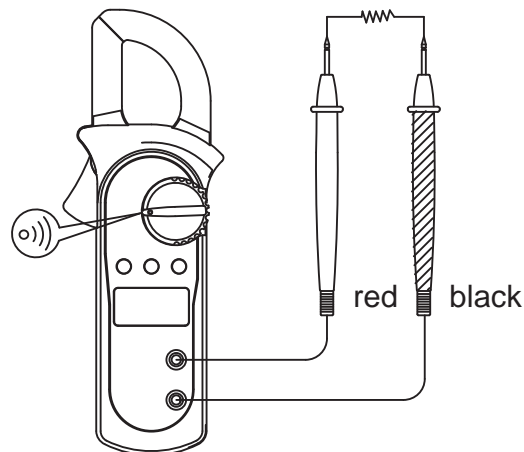

( figure 7)

### Measurement Operation(7)

#### Warning

To avoid damages to the Meter or to the devices under test, disconnect circuit power and discharge all the high-voltage capacitors before measuring continuity.

To test for continuity, connect the Meter as follows:

1. Insert the red test lead into the  $\bullet \rightarrow \text{V}\Omega$  terminal and the black test lead into the **COM** terminal.
2. Set the rotary switch to  $\Omega \bullet \rightarrow \text{V}\Omega$  and press **SELECT** button to select measurement mode.
3. The buzzer sounds if the resistance of a circuit under test is less than  $50 \Omega$ .
4. The buzzer may or may not sounds if the resistance of a circuit under test is between  $50 \Omega$  to  $120 \Omega$ .
5. The buzzer does not sound if the resistance of a circuit under test is higher than  $120\Omega$ .

#### Note

- 1 The buzzer beeps once when pressing any buttons at any rotary switch positions except at 2/20A positions if the button is valid. If the button is not valid, it does not beep. At 2/20A rotary switch position, the buzzer is set not to beep.
- 1 The buzzer beeps 5 times continuously on around 1 minute before entering the sleep mode. When it is just before entering the sleep mode, it will have one long beep to warn you.
- 1 The LCD displays **OL** indicating the circuit being tested is open.
- 1 When continuity testing has been completed, disconnect the connection between the testing leads and the circuit under test and remove testing leads from the input terminals.

## Measurement Operation(8)

### F. Temperature Measurement (UT202 Only)

(see figure 8)

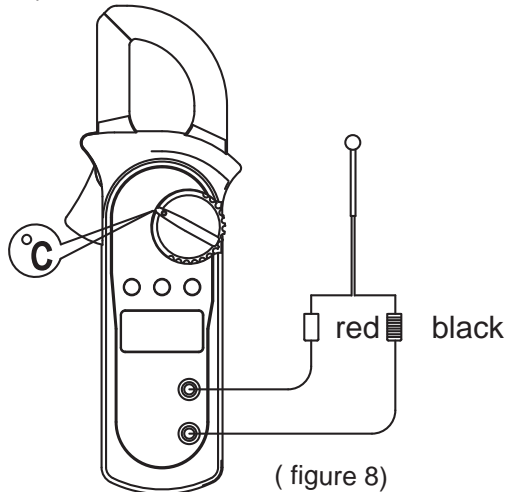

The temperature measurement ranges are  $-40^{\circ}\text{C}\sim 1000^{\circ}\text{C}$  and  $-40^{\circ}\text{F}\sim 1832^{\circ}\text{F}$ .

To measure temperature, connect the Meter as follows:

1. Insert the red temperature probe into the  $\text{V}\Omega$  terminal and the black temperature probe into the **COM** terminal.
2. Set the rotary switch to  $^{\circ}\text{F}/^{\circ}\text{C}$  and press **SELECT** button to select  $^{\circ}\text{F}$  or  $^{\circ}\text{C}$  measurement mode.  $^{\circ}\text{C}$  measurement mode is default.
3. Place the temperature probe to the object being measured. The measured value shows on the display.

#### Note

- 1 The Meter automatically displays the temperature value inside the Meter when there is no temperature probe connection.
- 1 When temperature measurement has been completed, disconnect the connection between the temperature probe and the circuit under test, and remove the temperature probe away from the input terminals of the Meter.

## Measurement Operation(9)

### G. AC Current Measurement (see figure 9)

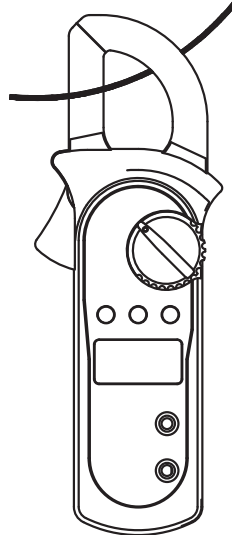

( figure 9)

#### Warning

To avoid electric shock, never measure current while the test leads are inserted into the input terminals and disconnect test leads and tested circuit connection.

**Never attempt an in-circuit current measurement where the open-circuit voltage between the circuit and the ground is greater than 600V**

**Use proper function and range for the measurement.**

The measurement ranges of current are: 2.000A, 20.00A, 200.0A and 400A.

To measure current, do the following:

1. Set the rotary switch to 2/20A $\sim$  or 200/400 A $\sim$
2. Press the lever to open the transformer jaws.
3. Center the conductor within the transformer jaw.  
The measured value shows on the display, it is a effective value of sine wave (mean value response).



Model UT201/202: OPERATING MANUAL

## Measurement Operation(10)

### Note:

- 1 To obtain accurate reading, measure only one conductor at each time.
- 1 When current measurement has been completed, disconnect the connection between the conductor under test and the jaw, and remove the conductor away from the transformer jaw of the Meter.



### Sleep Mode

To preserve battery life, the Meter automatically turns off if you do not turn the rotary switch or press any button for around 15 minutes.

The Meter can be activated by turning the rotary switch or pressing any button with the following conditions:

- 1) When the Meter is entered Sleep Mode at temperature functions of Model: UT202, the Meter cannot be activated by turning the rotary switch to AC current ranges.
- 2) By pressing any button must be according to "**The Effectiveness of Functional Buttons**" on page 12
- 3) The Hold function will be cancelled if the Meter is activated by pressing the **HOLD** button.

To disable the Sleep Mode function, press and hold **HOLD** button while turning on the Meter.

## Specifications

### A.General Specifications:

- 1 Maximum voltage including transient overvoltage between any terminals and grounding: 500V rms.
- 1 Display: 3 1/2 digits LCD display, Maximum display 1999
- 1 Auto Polarity Display
- 1 Overloading : Display **OL** or **-OL**
- 1 Battery Deficiency : Display
- 1 Measurement Speed : Updates 3 times/second.
- 1 Measurement Deviation : When the conductor being measured is not placed in a correct position during AC current measurement, it will cause  $\pm 1\%$  reading deviation.
- 1 Drop Test : 1 meter drop test passed.
- 1 Max. Jaw Size : 28mm diameter.
- 1 Projected Max. Current conductor size : 26mm diameter.
- 1 Power : 2pcs of 1.5V battery (AAA)
- 1 Battery Life : typically 150hours (alkaline battery)
- 1 Sleep Mode (can be disabled)
- 1 Dimensions (H x W x L) : 30mm x 76mm x 208mm.
- 1 Weight : Approximate 260g (battery included)

### B.Environmental Restrictions:

- 1 The Meter is suitable for indoor use.
- 1 Altitude : Operating: 2000m  
Storage: 10000m
- 1 Safety/ Compliances : IEC 61010 CAT.II 600V,  
CAT.III 300V over voltage  
and double insulation standard.
- 1 Temperature and humidity:  
Operating: 0°C~30°C ( $\leq 75\%$   
R.H); 30°C~40°C ( $\leq 70\%$ R.H);  
40°C~50°C ( $\leq 45\%$ R.H);  
Storage: -20°C~+60°C  
( $\leq 75\%$ R.H)

## Accurate Specifications(1)

Accuracy:  $\pm(a\% \text{ reading} + b \text{ digits})$ , guarantee for 1 year.

Operating temperature:  $23^{\circ}\text{C} \pm 5^{\circ}\text{C}$

Relative humidity:  $\leq 5\% \text{R.H}$

Temperature coefficient:  $0.1x(\text{specified accuracy})/1^{\circ}\text{C}$

### A. AC Voltage: Auto ranging

Range	Resolution	Accuracy	Overload Protection
2.000V	1mV	$\pm(1.2\%+5)$	600V rms
20.00V	10mV		
200.0V	100mV		
600V	1V	$\pm(1.5\%+5)$	

#### Remarks:

- 1 Input impedance:  $10\text{M}\Omega // <100\text{pF}$ "
- 1 Displays effective value of sine wave (mean value response).
- 1 Frequency response: 40Hz~1kHz.
- 1 To adjust reading in accordance with effective value

### B. DC Voltage: Auto ranging

Range	Resolution	Accuracy	Overload Protection
200.0mV	0.1mV	$\pm(0.8\%+3)$	600V rms
2.000V	1mV	$\pm(0.8\%+1)$	
20.00V	10mV		
200.0V	100mV		
600V	1V	$\pm(1\%+3)$	

Remarks: Input impedance:  $10\text{M}\Omega$  .

## Accurate Specifications(2)

### C. Resistance: Auto ranging

Range	Resolution	Accuracy	Overload Protection
200.0Ω	100mΩ	±(1.2%+2)	600Vp
2.000kΩ	1Ω	±(1%+2)	
20.00kΩ	10Ω		
200.0kΩ	100Ω		
2.000MΩ	1kΩ	±(1.2%+2)	
20.00MΩ	10kΩ	±(1.5%+2)	

**Remarks:** Input impedance: 10MΩ .

### D. Continuity Test

Range	Resolution	Accuracy	Overload Protection
•••)	100mΩ	Around ≤ buzzer beeps	600Vp <sup>50Ω</sup> the

**Remark:**

- 1 Open circuit voltage approximate 0.45V.
- 1 The buzzer may or may not beeps when the resistance of a circuit under test is between 50Ω and 120Ω  
The buzzer may not beep when the resistance of a circuit under test is greater than 120Ω.

### E. Diode Test

Range	Resolution	Accuracy	Overload Protection
→	1mV	Display approximate forward voltage drop : 0.5V~0.8V	600Vp

**Remarks:** Open circuit voltage approximate 1.48V.

### Accurate Specifications(3)

#### F. Temperature (UT202 Only):

Range	Resolution	Accuracy	Overload Protection
-40~1000°C	1°C	-40~0°C: ±(3%+4)	600Vp
		0~400°C: ±(1%+3)	
		400~1000°C: ±(2%+10)	
-40°F~1832°F	1°F	-40~32°F: ±(3%+8)	
		32°F~752°F: ±(1%+6)	
		752°F~1832°F: ±(2%+18)	

#### G. AC Current: Auto ranging

Range	Resolution	Accuracy	Frequency Response	Overload Protection
2.000A	0.001A	<1A(4%+40) ≥1A(3%+30)	50Hz~60Hz	400A rms
20.00A	0.01A	±(3%+12) ≤ 4A		
		±(2%+8)		
200.0A	0.1A	±(1.5%+5)		
400A	1A			

#### Remarks:

- 1 Displays effective value of sine wave (mean value response).  
To adjust reading in accordance with effective value

## MAINTENANCE(1)

This section provides basic maintenance information including battery replacement instruction.

### Warning

**Do not attempt to repair or service your Meter unless you are qualified to do so and have the relevant calibration, performance test, and service information.**

**To avoid electrical shock or damage to the Meter, do not get water inside the case.**

### A. General Service

- 1 Periodically wipe the case with a damp cloth and mild detergent. Do not use abrasives or solvents.
- 1 To clean the terminals with cotton bar with detergent, as dirt or moisture in the terminals can affect readings.
- 1 Turn the Meter power off when it is not in use.
- 1 Take out the battery when it is not using for a long time.
- 1 Do not use or store the Meter in a place of humidity, high temperature, explosive, inflammable and strong magnetic field.

### B. Replacing the Battery (see figure 10)

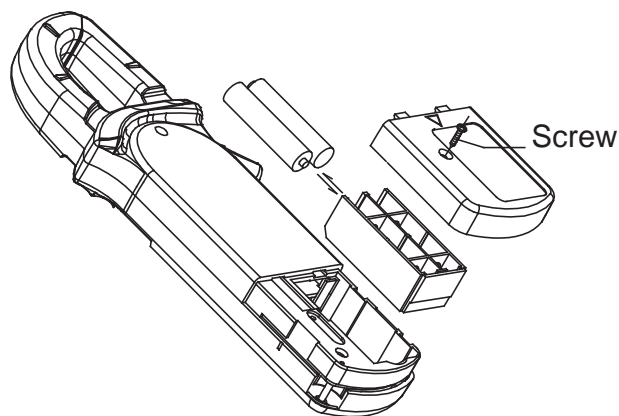

( figure 10)

## MAINTENANCE(2)

### Warning

To avoid false readings, which could lead to possible electric shock or personal injury, replace the battery as soon as the battery indicator “” appears.

**Make sure the transformer jaw and the test leads are disconnected from the circuit being tested before opening the case bottom.**

To replace the battery:

1. Turn the Meter off and remove all the connections from the input terminals
2. Turn the Meter's case top down.
3. Remove the screw from the battery compartment, and separate the battery compartment from the case bottom.
4. Remove the old battery from the battery compartment.
5. Replace the battery with 2pcs of new 1.5V (AAA) battery.
6. Rejoin the case bottom and the battery compartment, and reinstall the screw.

\*\* END \*\*

This operating manual is subject to change without notice.

# UNI-T®

**Model UT201/202: OPERATING MANUAL**

©Copyright 2001 Uni-Trend Group Limited.  
All rights reserved.

Manufacturer:  
Uni-Trend Technology (Dongguan) Limited  
Dong Fang Da Dao  
Bei Shan Dong Fang Industrial Development District  
Hu Men Town, Dongguan City  
Guang Dong Province  
China  
Postal Code: 523 925

Headquarters:  
Uni-Trend Group Limited  
Rm901, 9/F, Nanyang Plaza  
57 Hung To Road  
Kwun Tong  
Kowloon, Hong Kong  
Tel: (852) 2950 9168  
Fax: (852) 2950 9303  
Email: [info@uni-trend.com](mailto:info@uni-trend.com)  
<http://www.uni-trend.com>